



KONICA MINOLTA

Conforms to JIS A Class and DIN Class C

NEW

CRI Illuminance Meter

CL-70F 1

Easy to use !

Can take spectral measurements of flash light

Good tool for lighting planners



Rotating receptor head



Dark calibration performed without needing cap



Measurement and evaluation of the illuminance, color temperature, and color-rendering index of special illumination sources used for restaurants, museums, studios, and stages, etc.



Easy-to-read display *Display mode examples

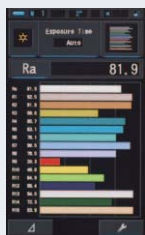

Color rendering index



CIE1931 (CIE1964)

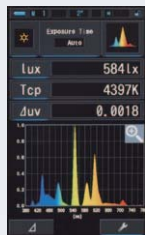

Spectrum

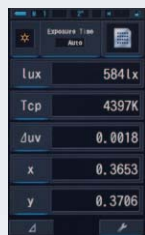

Text

Measurement and evaluation of the illuminance, color-temperature, and color-rendering index of indoor illumination sources such as LEDs, fluorescent lamps, etc.



System Diagram

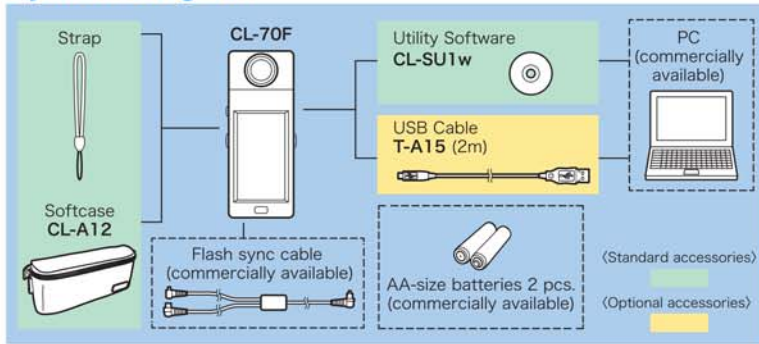

Dimensions (Units: mm)

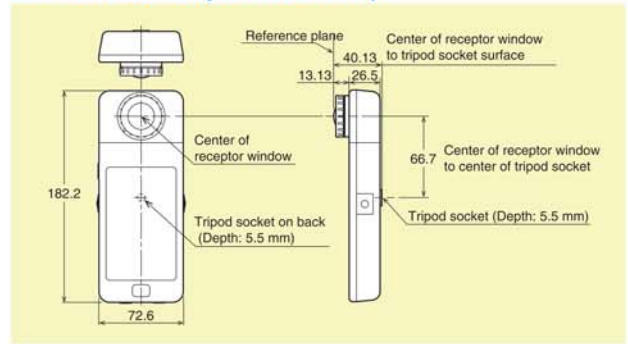

Main Specifications of CL-70F

Model	CRI Illuminance Meter CL-70F
Illuminance meter class	Conforms to requirements for Class A of JIS C1609-1 : 2006 "Illuminance meters Part1:General measuring instruments; Conforms to DIN 5032 Part 7 Class C
Sensor	CMOS linear image sensor
Spectral wavelength range	380 nm ~ 780 nm
Output wavelength pitch	1 nm
Measuring range	Constant light: 1 to 200,000 lx; 1,563 to 100,000 K (Chromaticity display requires 5 lx or more) Flash light: 20 to 20,500 lx·s; 2,500 to 100,000 K
Accuracy (Standard Illuminant A) (*1, 2)	E _v : ±5%±1digit of displayed value xy: ±0.003 (at 800 lx)
Repeatability (Standard Illuminant A) (*1)	E _v : 30 to 200,000 lx: 1%+1digit; 1 to 30 lx: 5%+1digit (*3) xy: 500 to 200,000 lx: 0.001 (*4) xy: 100 to 500 lx: 0.002 (*4) xy: 30 to 100 lx: 0.004 (*4) xy: 5 to 30 lx: 0.008 (*4)
Visible-region relative spectral response characteristics (f1')	Within 9%
Cosine correction characteristics (f2)	Within 6%
Temperature drift (f _t)	E _v : ±5% xy: ±0.006
Humidity drift (f _h)	E _v : ±3% xy: ±0.006
Power	2 AA-size batteries (Alkaline batteries or manganese dry cells); USB bus power
Response time	Constant light (Maximum): 15 sec Constant light (Minimum): 0.5 sec Flash light: 1 ~ 1/500 sec (in 1-step intervals) (*5)
Color indication modes	Correlated color temperature T _{cp} , Difference from blackbody Δuv, XYZ, xy, u'v', Dominant wavelength λ _d , Excitation purity P _e , Spectral irradiance, E _v , CRI (Ra, Ri), Peak wavelength λ _p , exposure value
Other functions	Data memory: 999 data; Preset function; Auto power off function
Display languages	English, Japanese, Chinese (Simplified)
Interface	USB 2.0 Mini B
Operation temperature/humidity range	-10 to 40°C, relative humidity of 85% or less (at 35°C) with no condensation
Storage temperature/humidity range	-10 to 45°C, relative humidity of 85% or less (at 35°C) with no condensation
Size	73 (W)× 183 (H) × 27 (D) mm (Not including projecting buttons) D (max): 40 mm
Weight (without battery)	230 g

(*1) Measurement mode: Constant light (range L), Exposure time : AUTO (*4) 10 times measurement (2σ)
 (*2) Linear for E_v (*5) Shutter speed
 (*3) 10 times measurement (2σ) / Ave

- KONICA MINOLTA and the Konica Minolta logo and the symbol mark, and "Giving Shape to Ideas" are registered trademarks or trademarks of KONICA MINOLTA, Inc.
- The specifications and appearance shown herein are subject to change without notice.
- Screens shown are for illustration purpose only.
- Some lamp control methods may make accurate measurements difficult. For details, please contact your nearest Konica Minolta sales office or dealers.



SAFETY PRECAUTIONS

For correct use and for your safety, be sure to read the instruction manual before using the instrument.

- Be sure to use the specified batteries. Using improper batteries may cause a fire or electric shock.

KONICA MINOLTA, INC.
Konica Minolta Sensing Americas, Inc.
Konica Minolta Sensing Europe B.V.

Konica Minolta (CHINA) Investment Ltd.

Konica Minolta Sensing Singapore Pte Ltd.
Konica Minolta Sensing Korea Co., Ltd.
Konica Minolta, Inc.

Osaka, Japan
 New Jersey, U.S.A.
 European Headquarter /BENELUX
 German Office
 French Office
 UK Office
 Italian Office
 Swiss Office
 Nordic Office
 Polish Office
 SE Sales Division
 Beijing Office
 Guangzhou Office
 Chongqing Office
 Qingdao Office
 Wuhan Office

Sensing Business
 Thailand Representative Office

Phone : 888-473-2656 (in USA), 201-236-4300 (outside USA)
Phone : +31 (0) 30 248-1193
Phone : +49 (0) 89 4357 156 0
Phone : +33 (0) 1 80 11 10 70
Phone : +44 (0) 1925 467300
Phone : +39 02849488.00
Phone : +41 (0) 43 322-9800
Phone : +46 (0) 31 7099464
Phone : +48 (0) 71 73452-11
Phone : +86- (0)21-5489 0202
Phone : +86- (0)10-8522 1551
Phone : +86- (0)20-3826 4220
Phone : +86- (0)23-6773 4988
Phone : +86- (0)532-8079 1871
Phone : +86- (0)27-8544 9942
Phone : +65 6563-5533
Phone : +82 (0) 2-523-9726
Phone : +66-2361-3730

Fax : 201-785-2482
Fax : +31 (0) 30 248-1280
Fax : +49 (0) 89 4357 156 99
Fax : +33 (0) 1 80 11 10 82
Fax : +44 (0) 1925 711143
Fax : +39 02849488.30
Fax : +41 (0) 43 322-9809
Fax : +48 (0) 71 734 52 10
Fax : +86- (0)21-5489 0005
Fax : +86- (0)10-8522 1241
Fax : +86- (0)20-3826 4223
Fax : +86- (0)23-6773 4799
Fax : +86- (0)532-8079 1873
Fax : +86- (0)27-8544 9991
Fax : +65 6560-9721
Fax : +82 (0) 31-995-6511
Fax : +66-2361-3771



Certificate No : LRG 0960094/A Registration Date : March 3, 1995
 Certificate No : JQA-E-80027 Registration Date : March 12, 1997

Utility Software (Standard accessory)

Software	OS	
Windows	Windows [®] 7 SP1 Windows [®] 8 Windows [®] 8.1	Compatible with 32-bit and 64-bit versions of Excel [®]

* Windows[®] and Excel[®] are trademarks of Microsoft Corporation in the USA and other countries.

Konica Minolta's Illuminance Measurement Trio <All conforms to JIS AA Class>

Illuminance Spectrophotometer CL-500A For industrial applications requiring high accuracy

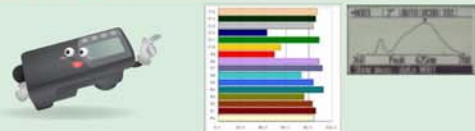

Chroma Meter CL-200A A de facto industry standard for color-temperature measurement !

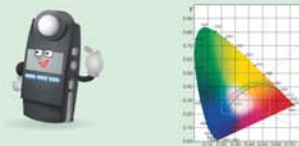

Illuminance Meter T-10A Capable of accurately measuring next-generation lamps including PWM-controlled lighting.

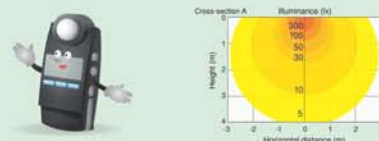

* Both CL-200A and CL-500A also can measure PWM-controlled light.

Addresses and telephone/fax numbers are subject to change without notice. For the latest contact information, please refer to the KONICA MINOLTA Worldwide Offices web page :

©2015 KONICA MINOLTA, INC.

<http://konicaminolta.com/instruments/network>

9242-4876-14 BFHPK Printed in Japan